

Ardente MK II

(BLUEAMP Op.5, No.2)

ALL-IN-ONE INTEGRATED STEREO AMPLIFIER
INSTRUCTION BOOK
150W + 150W



- Please be sure to read the "USER MANUAL" before using and then use accurately
- The information contained in this USER MANUAL is subject to change without prior notice
in order to improve the performance of the product.

CONTENTS

01	Product Introduction / Features / Componets
02	Product Structure
03~05	Product Usage
06	Product Specifications
07	Safety Precautions
07	Troubleshoot
08	Product Warranty

Product Introduction

BIT & BEAT AUDIO "ARDENTE MK II" (BLUEAMP Op.5, No.2) allows you to directly the functions that suit your audio environment, This allows you to build an optimal sound system at a reasonable cost. It's a Hi-Fi integrated amplifier with a new sensation.

Features

BIT & BEAT AUDIO "ARDENTE MK II" (BLUEAMP Op.5, No.2) is advanced product which perform exceptional sound as functions below.

"Analog(Analog Sound) natural sound with a warmth of the sound and sence"

Analog sound expression, like a tube, a relax feeling that does not get tired easily even if you listen for a long time. The tuning point of the balance is an uncompromising tone, and the ideal sound that embodies the dream of 'Audio files'

"Implementing a smooth power supply with a large capacity toroidal transformer [Toroidal Transformer]"

High-quality, which ensures wide dynamic range with stable driving ability through ultra fast rectification and regulation provides sound, seamlessly and without power, for the dynamic peak

" Innovative proprietary integrated circuit design methodology of HI -FI Integrated Amplifier "

Unique, full discrete audio circuit is composed of a drive amplifier, making it possible to capture fine sound Reproduces all of the sounds expressed by the sound source in a dynamic and detailed expression of quietness and deepening background sound

"ALL-IN-ONE AUDIO (all-in-one audio system) extension"

BLANCE, UNBALANCE analog input expansion and AES / EBU, I2S, BNC through optional custom expansion board (sold separately) selectable 9 potions of Bluetooth, PHONO EQ, USB DDC, DAC are preferred for digital input expansion and audio files

* To use digital input expansion board, DAC expansion board must be installed.

Components



BLUEAMP Body

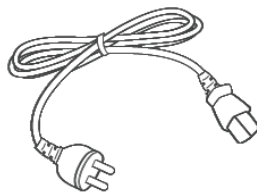

Power cable (AC 220V)

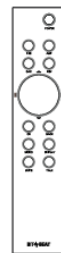

Remote control
(built-in battery)

* The image of this product manual is for user's understanding and may differ form the actual product and may be changed without prior notice.

* Other ones than basic components can be purchased separately.

Product Structure

Front



Rear

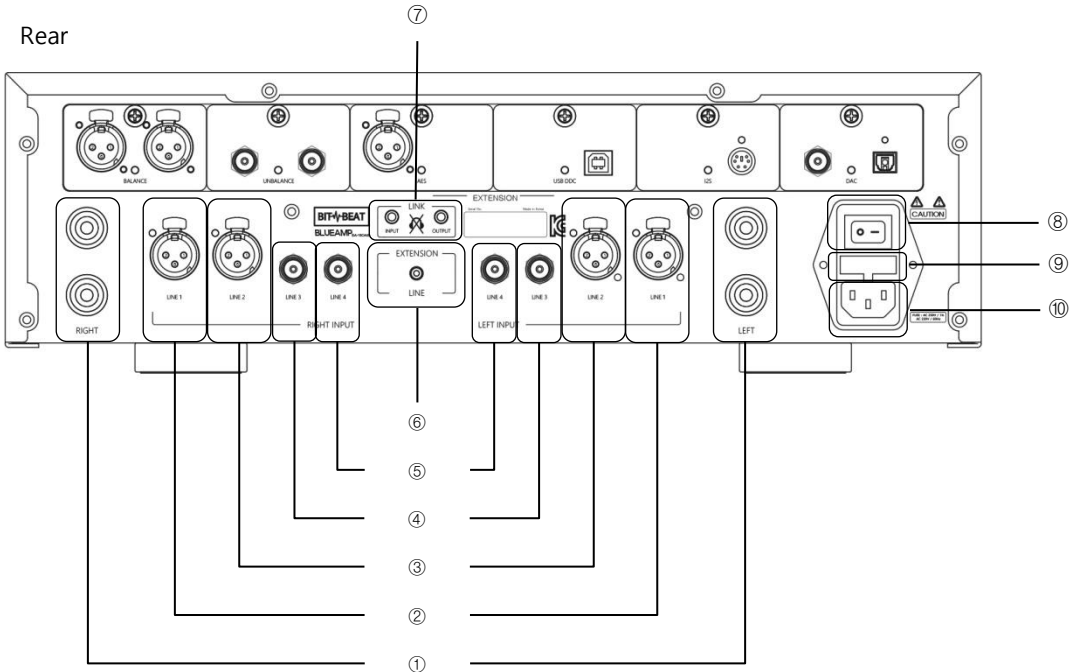

- ① Speaker connection terminal
- ② LINE Input 1(BALANCE)
- ③ LINE Input 2(BALANCE)
- ④ LINE Input 3(UNBALANCE)
- ⑤ LINE Input 4(UNBALANCE)
- ⑥ Priority Input
- ⑦ BLUE LINK terminal BLUE series connection terminal
※Never plug in any other company's products or earphones.
- ⑧ Power switch ※Please keep the power off if you are not using it for long time.
- ⑨ FUSE Holder FUZE 250V T8A
- ⑩ Power Input AC 220V / 60Hz



Up to 6 EXPANSION option boards can be mounted, switch to select the starting position when turning on the power to provide user convenience

※ ⑥ When select switch is in LINE : Start to use in order of LINE 1,2,3,4 < EXPANSION 1,2,3,4,5,6
 ⑥ When select switch is in EXPANSION : Start to use in order of EXPANSION 1,2,3,4,5,6 <LINE 1,2,3,4>

Product Usage

All-in-one Audio Function

Optional(sold separately) customized board has BALANCE, UNBALANCE, AES/EBU, I2S, BNC, Bluetooth Receiver, PHONO EQ, USB DDC, DAC, so you can configure it with the product you want. Up to 6 optional boards can be mounted. To use the digital input expansion board, a DAC expansion board should be installed.

Rear

[Example of optional features]

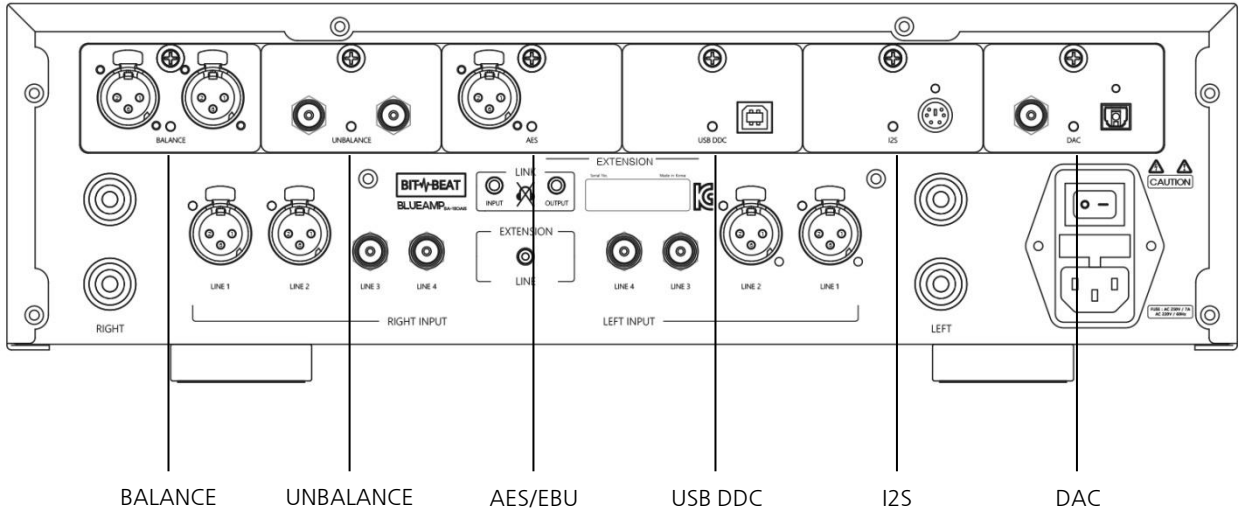

Analog	① BALANCE	Analog Input
	② UNBALANCE	Analog Input
	③ Bluetooth	Connect Computer or Smart device by Bluetooth receiver module
	④ PHONO EQ	PHONO Equalization Module
Digital	⑤ AES/EBU	Digital Input
	⑥ USB DDC	PCM 384Khz/32Bit, Native DSD 256 song play function
	⑦ I2S	Digital Input
	⑧ DAC (OPTICAL , COXIAL)	High resolution source (Maximum 384KHz/32bit) D/A convertor
	⑨ BNC	Digital Input

*For extension module installation and removal be sure to turn off the power switch at the rear of the device and wait for more than a minute before proceeding. (Due to the large amount of capacitor fitted to the inside of AMP, a sufficient amount of time must Elapse after the device is switched off

Product Usage

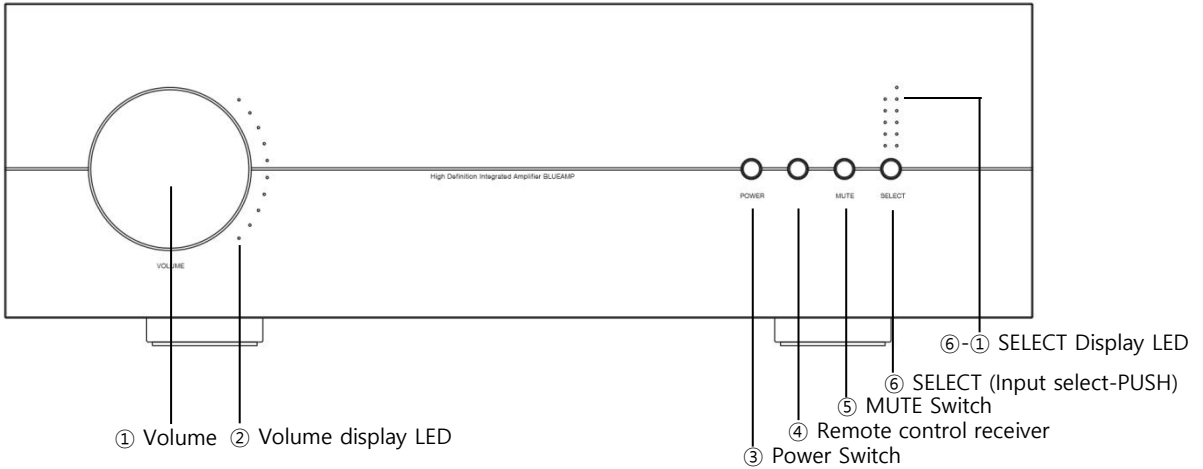

Table 1	
① Volume	Volume Function
	Turn clockwise to turn up the volume(+)
	Turn counterclockwise to turn down the volume(-)
	Input Selection(PUSH)
	Press once to change in order of LINE 1,2,3,4
② Volume indicator LED(Power ON)	Default selection LED ON (Green)
③ Power Switch	Power ON
	Hold for longer than 2 seconds
	Power OFF
	Hold for longer than 2 seconds
④ Remote control receiver	
⑤ MUTE Switch(Mute Function)	Press once MUTE ON
	Red LED will start blinking quickly : Muted
	Press once more MUTE OFF
	MUTE LED OFF
⑥ SELECT	Without extend module, the green LED turns on in order of LINE 1,2,3,4
⑥-① SELECT Display LED	Table 2 With rear extend module, the orange LED turns on in order of OPTION 1~6
	When rear ⑥ switch is on LINE : the green LED turns on in order of LINE 1,2,3,4
	With rear ⑥ switch is on EXTENSION : the orange LED turns on in order of OPTIONLINE ①~⑥ (However, only the number of extend module is active)



Volume indicator LED indicate the level of volume, as displayed by the table below.

Volume indicator LED	Stage	LED color	Volume
	① #1	Green	Mute(-112dB)/-111.5dB~-66.0dB
	② #2	Green	-65.0dB ~ -46.0dB
	③ #3	Green	-45.5dB ~ -36.5dB
	④ #4	Green	-36.0dB ~ -28.0dB
	⑤ #5	Green	-27.5dB ~ -20.5dB
	⑥ #6	Green	-20.0dB ~ -14.5dB
	⑦ #7	Green	-14.0dB ~ -9.5dB
	⑧ #8	Green	-9.0dB ~ -5.5dB
	⑨ #9	Green	-5.0dB ~ -2.5dB
	⑩ #10	Red	-2.0dB ~ 0dB

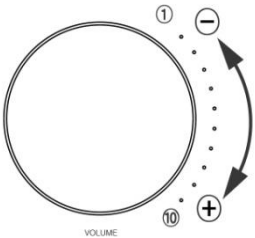
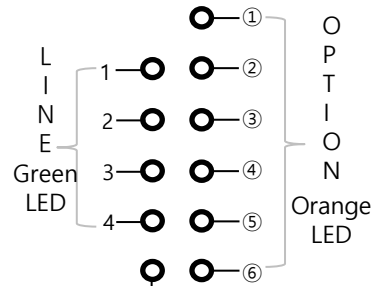

Table 1

Table 2 SELECT LED



(However, Orange LED will be turn on only when the optional Board is located)

TALK	Adjust volume to allow conversation
	Red LED will begin blinking slowly
MUTE	Mute
	Red LED will begin blinking quickly

Product Usage

1. Input channel and volume storage function : Press MUTE + SELECT switch at the same time to save.
 - Press the MUTE + SELECT buttons at the same time to save the selected channel while the LED blinks.
 - By saving the current state of input channel and sound level are automatically applied when the amplifier is restarted
 - When a user commits a save, the input priority switch on the back is ignored and the user save value takes precedence.
 - A factory reset or no save is applied by the input priority switch on the back.
2. When the initial power is turned on, mute mode is off, or talk mode is off, the volume gradually increases.
 - Initial power ON : Gradually increases the volume from 0 to initial (saved) volume.
 - Mute Off : Gradually increase the volume from 0 to the initial (saved) volume value.
 - Talk Off: The volume is gradually increased from the volume in the talk mode to the original volume.
3. When the volume is increased again from the maximum level, the volume is automatically set to the level of the talk mode.
4. Factory reset to channel and volume settings
 - After the power switch on the back of the amplifier is turned OFF and the switch is turned on while pressing the mute switch on the front, factory reset is performed.
 - At this time, if the rear switch is positioned at line, the input starts at line 1, if it is at expansion, expansion 1 starts and the sound level is initialized to the factory-set level.

Remote control function description

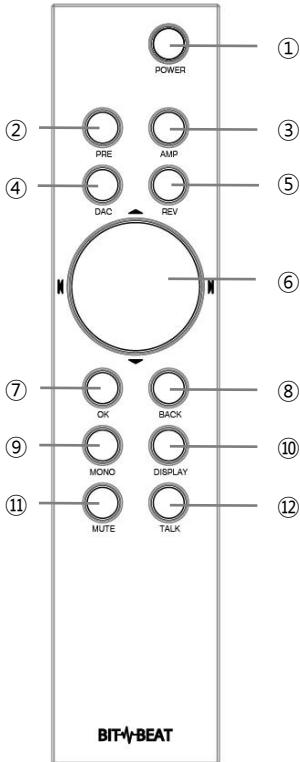

Please select the device (PRE,AMP,DAC,REV) you are willing to operate.

①	POWER Button
②	PRE
③	AMP
④	DAC
⑤	REV
⑥	Volume Button, Input Select Button
	▲ Turn up the volume by 0.5dB > : Select following channel
	▼ Turn down the volume by 0.5dB < : Select previous channel
⑦	OK
⑧	BACK
⑨	MONO
⑩	DISPLAY
⑪	MUTE(Mute Function)
	Press once MUTE ON Red LED will begin blinking quickly : Muted
	Press once more MUTE OFF MUTE LED OFF
⑫	TALK(Talk Function)
	Press talk button to adjust volume which allow conversation, Red LED will begin blinking slowly, Press talk button again to return to the original volume
	✘ Sometimes the device fails to operate due to the user pressing incorrect button on the remote. Please select the device (PRE,AMP,DAC,REV) you are willing to operate.

Product Specifications

	Specification	Contents
Model name		BA-150AIS Ardente MK II (BLUEAMP Op.5, No.2)
Dimension	W x H x D [mm]	451mm × 144.5mm × 447mm
Weight	kg	20.2kg
Input		LINE 1 (BALANCE) LINE 2 (UNBALANCE) LINE 3 (UNBALANCE) LINE 4 (UNBALANCE) LINE 5 (EXPANSION INPUT, MAX 6EA)
Output	Speaker	RMS 150W×150W
Input Sensitivity / Output		1Vrms / 150W per CH
Frequency Characteristics		10Hz ~ 100KHz +0dB/-0.1dB
THD+N		0.008%
S/N		100dB
GAIN		30dB
Input Impedance		BALANCE 47KΩ + 47KΩ UNBALANCE 47KΩ
Output Impedance		4Ω ~ 16Ω
Power		AC220V / 60Hz (FUSE 250V T8A)
Power Consumption		Min 35W, Max 470W
Balanced Input Pin Assignment		PIN1-----Ground PIN2-----Hot(Positive) PIN3-----Cold(Negative)
Remarks		※If fuse in use is replaced, be sure to use a fuse to the rated voltage.



* This device may be exposed to heat when used at high volume for long periods of time.

*Avoid use in confined spaces or places where ventilation is not free. especially please keep out of reach of infants and children.

Safety Precautions



WARNING

-
- This product is a one that generates a basic heat, so a heat may be detected when used for a long time.
 - Install the product at a distance from the walls and peripherals to ensure proper ventilation
-
- Use this device at normal room temperature.
 - Avoid hot places like flames. Stoves, and flammable materials.
 - Avoid places with high humidity. It may cause electric shock or malfunction.
-
- In case of thunder or lightning, please unplug the power cord. It may cause damage to the product due to overcurrent.
 - In case of damage due to an accident such as foreign matter entering the product or falling, please remove the power plug.
-
- Use only accessories or components authorized by the seller or manufacturer.
 - Failure to do so may result in injury, overheating, or fire due to abnormal operation. The seller or the manufacturer can not be held responsible for any damage or malfunction of the product caused by user's arbitrary change or modification.
-



CAUTION

-
- Short the speaker terminals (+/-) and never operate
-
- Do not handle this device with wet hands, as it is an electronic device that is supplied with power.
-
- Be careful not to apply strong impact to the device. Internal important parts or transformer fixing parts can be damaged.
 - Insert the power plug firmly. In case of shaking or unstable condition, it may cause fire or other accidents.
-
- Be careful that the power cord is not pressed against heavy objects such as furniture or caught by feet, and the damaged power cord should be replaced immediately.
-
- Do not place containers, lights or candles containing liquids such as vases, flower pot, or cups near the products.
 - When cleaning the product, please use a dry towel. There is a risk of product variation.
-

! If you notice odor or noise when using the product, stop using it and contact your dealer immediately for action.

Troubleshooting

This manual will help you solve the most common problems.

Power is not turned on.

- + Check if the power cord is properly connected.

No sound is heard.

- + Check if the cable is properly connected to the input and output terminals of the product.
- + Make sure the device connected to the input matches the selected number.

Sound quality is poor and distorted.

- + Are all the cables connected correctly? If necessary, turn off the power, disconnect the connector, and then reconnect it. Then turn the power on again.

! This product requires aging time on the nature of the device.

! If you have any questions about using the BLUEAMP device, please contact your dealer.

Product Warranty

About the Product

- Based on the consumer compensation regulations, a warranty for the product will be provided, as shown below.

**Warranty period:
1 (one) year from
date of purchase**

Product name		Purchase Date		Serial No.	
Model name		Where to purchase		Sale Price	

Consumer Damage types	failures and defects in performance, functions that occurs naturally during normal use within retention period of the parts	Compensation details	
		Within the warranty period	After the warranty period
	If the product is in need of major repairs within 10 days after purchased	Product replacement Or refund of the purchase price	—
	If critical parts are in need of repairs within 1 month after purchased	Product replacement	
	If the replaced product is in need of major repairs within a month after replaced	Refund Of The purchase price	
	When replacement of parts is not possible		
Repairs Available	If defects in the product are caused	Free repair	Paid repair
	After repairing, the same defects of a product are generated 4 th times	Product replacement Or Refund Of Purchase price	—
	Failures of the various parts are repaired, but a failure is regenerated (5 th times)		
When repair is not possible			
Repair is Not Possible	If repair parts cannot be repaired after the retention period has passed	Product replacement	—
	Damage caused during transportation and installation process when purchasing products		

*Refunds : Refund the purchase price (receipts to be submitted)

Please contact us for maintenance and repair at following phone number. If you send us brief information about a fault condition In case a failure, it will be more convenient

The following failures will be treated at cost.

- Failure due to user negligence
- Connection to the power supply other than rated power
- Failure due to user negligence
- Deliberate disassembly and repair by the user
- Breakdown by natural disasters (fire, flood, earthquake, lightning, etc.)
- When supplies are replaced

Contact : Sales

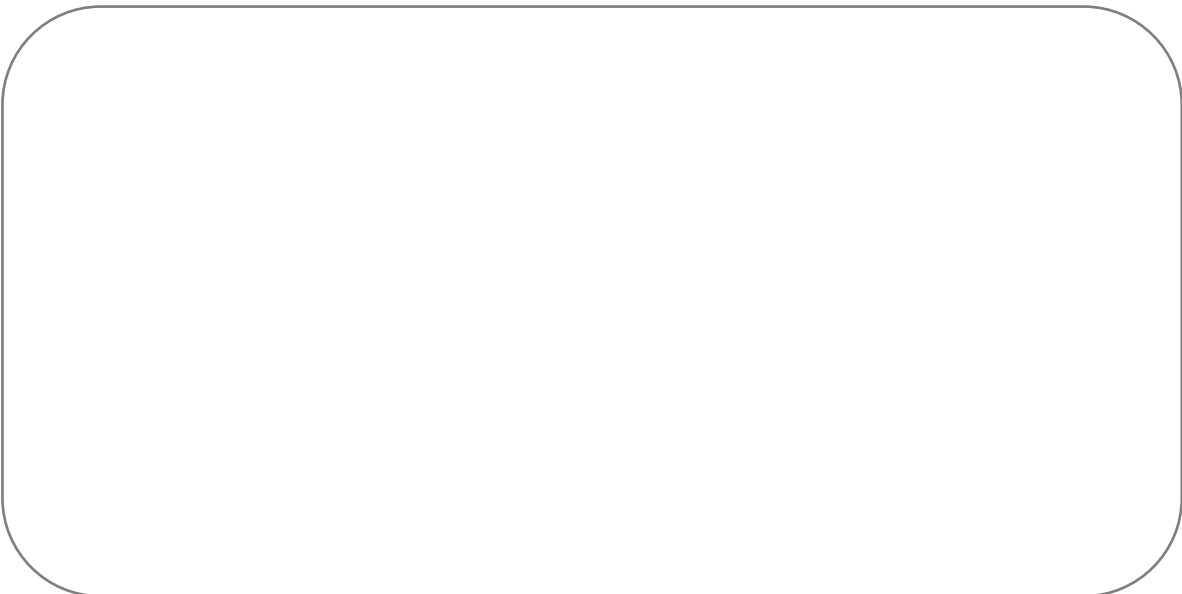



"Ardente MK II"
(BLUEAMP Op.5, No.2)